



Single Port USB to RS422 / 485 adapter

Product Manual



Coolgear, Inc.

Version 1.1

September 2017

Model Number: USB-COM-i

Revision History

| Revision | Date | Author | Comments |
|----------|------------|----------|------------|
| 1.0 | 02/27/2018 | Coolgear | New Manual |

About this document

This product manual outlines installation and features of the USB-COM-i Single Port USB to RS422 / 485 adapter.

Scope

The scope of this manual is to give the user of the product an understanding of its use with detailed diagrams and verbiage. The manual allows the users to apply the product to their application.

Intended Audience

This product is intended for use in numerous industries including but not limited to applications such as; Factory Automation, Data Centers, Serial Equipment, Kiosk, Office, and others.

Product Support

support@coolgear.com

Table of Contents

| | |
|--|-----------|
| 1. Introduction | 4 |
| 1.1 Features | 4 |
| 2. Hardware / Software Installation | 5 |
| 2.1 Termination and BIAS Option Configuration | 6 |
| 2.2 Windows 7 / Vista / 2003 / XP / 2000 Driver Installation..... | 7 |
| 2.3 Check Installation..... | 8 |
| 2.4 Change COM Port Properties and COM Port Number..... | 8 |
| 2.5 Uninstalling Windows 2003 / XP / 2000 Drivers..... | 9 |
| 2.6 Uninstalling Windows 7 or Vista Drivers | 11 |
| 3. DB-9 Male Connector Pin & Signal Assignment | 14 |
| 3.1 RS-422 Signal Pin-outs of DB-9 Male | 14 |
| 3.2 RS-485 4-Wire (Full Duplex) Signal Pin-outs of DB-9 Male..... | 15 |
| 3.3 RS-485 2-Wire (Half Duplex) Signal Pin-outs of DB-9 Male | 15 |
| 4. Notes, Tips, and Warnings | 17 |
| 5. Supporting References | 18 |

Table of Figures

| | |
|---|----------|
| Figure 1 - Opening the Case..... | 5 |
| Figure 2 – DIP Switch Control..... | 6 |
| Figure 3 – Termination and BIAS resistors..... | 7 |
| Figure 4 – Windows Drivers Installation..... | 8 |
| Figure 5, 6, 7, 8, 9, 10 – Uninstalling Windows XP Drivers..... | 9-10 |
| Figure 11, 12, 13, 14, 15 – Uninstalling Windows 7 Drivers..... | 11-12-13 |
| Figure 16 – DB-9 Male Connector Pins..... | 15 |
| Figure 17, 18 – RS-422 Signal Wiring..... | 15-16 |
| Figure 19, 20 – RS-485 Signal Wiring..... | 16-17 |

1. Introduction

The USB-COM-i Industrial Single RS-422/485 Adapters are designed to make serial port expansion quick and simple. Connecting to a USB port on your computer or USB hub, the USB Serial Adapter instantly adds one industrial RS-422/485 multi-electrical interface serial communication port to your system. The adapter is designed with external switches to set RS-422 or RS-485 ports and different operation modes conveniently.

| | |
|------------|--|
| WEIGHT | .156 lbs |
| DIMENSIONS | 84.40(L)x72.99(W)x42.24mm(H) |
| UPC | 729440691448 |
| WARRANTY | 1 year from date of purchase |
| COLOR | Blue / Gray |
| PORTS | 1 DB-9 Serial Port / 1 USB-B Female Port |

1.1 Features

| | |
|--|--|
| <ul style="list-style-type: none"> • TAA Compliant • Adds one high speed RS-422 / 485 serial port via USB connection • 384 byte receive buffer • 128 byte transmit buffer for high speed data throughput • Requires no IRQ, DMA, I/O port • Data rates: 300 bps to 921.6K bps • Serial Connector: one DB-9 male connector • Auto transmit buffer control for 2-wire RS-485 half-duplex operation | <ul style="list-style-type: none"> • Termination resistors and BIAS resistors installed on-board • RS-422 data signals: Tx-, Tx+, Rx+, Rx-, GND, RTS-, RTS+, CTS+, CTS- • RS-485 data signals: Tx-, Tx+, Rx+, Rx-(4 wire) and data-, data+ (2 wire) • Monitor LEDs of TxD, RxD indicating port status • No external power adapter required • Virtual COM port drivers available for Windows 7, Vista, 2003, XP, 2000 |
|--|--|

2. Hardware / Software Installation

Inside the unit, there is one 3-pin DIP switch for selection of operation mode. You need to open up the plastic housing by using a screw driver as shown below. You can set the switch settings to RS-422 or RS-485 mode as per the requirements of your application.

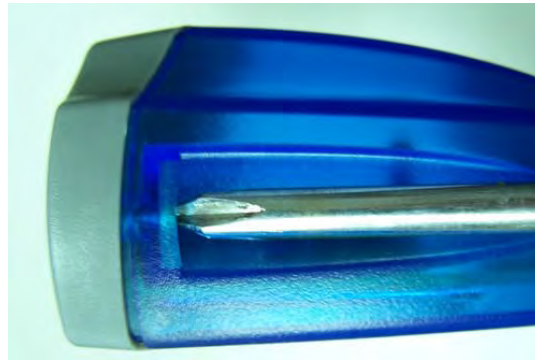

Figure 1

Open the case

You need to install driver first, prior to hardware installation. After the setting of DIP switch and connecting USB cable to the adapter, you then start driver installation.

The Mode Block Configuration Settings are listed as follows:

RS-422 & RS-485 Mode Block Configuration SW (DIP Switch) for Mode Setting

| | Operation Mode | S1 | S2 | S3 |
|---------------|--|-----|-----|-----|
| RS-422 | 4 wire with Handshaking | ON | ON | ON |
| RS-485 | Full Duplex (4 wire) | OFF | ON | ON |
| | Half Duplex (2 wire) - With Echo | OFF | OFF | ON |
| | Half Duplex (2 wire) - Without Echo | OFF | OFF | OFF |

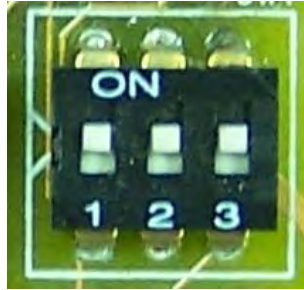

Figure 2

3-Pin DIP Switch for Operating Mode Selection

2.1 Termination and BIAS Option Configuration

Inside the unit, there is one block of 3 x 7 (21 pin) jumpers which are configured to enable Tx, Rx, CTS 120 Ohm termination resistors and Tx, Rx 750 Ohm BIAS resistor.

You will need to open up the case and set the jumper setting to activate termination and BIAS as per the requirements of your application.

Settings are listed as follows:

| Jumper | | Function |
|--------|---------|---|
| 1-2 | enable | Tx Termination of 120 Ohm. This jumper should always be populated for RS-485 mode. |
| 2-3 | disable | |
| 4-5 | enable | Pull-up Tx+ to VCC by 750 Ohm Bias resistor. This jumper should be populated for pull-up Tx+. |
| 5-6 | disable | |
| 7-8 | enable | Pull-down Tx- to GND by 750 Ohm Bias resistor. This jumper should be populated for pull-down Tx- . |
| 8-9 | disable | |
| 10-11 | enable | Rx Termination of 120 Ohm. This jumper should always be populated for RS-422 mode. |
| 11-12 | disable | |
| 13-14 | enable | Pull-up Rx+ to VCC by 750 Ohm Bias resistor. This jumper should be populated for pull-up Rx+. |
| 14-15 | disable | |
| 16-17 | enable | Pull-down Rx- to GND by 750 Ohm Bias resistor. This jumper should be populated for pull-down Rx- . |
| 17-18 | disable | |
| 19-20 | enable | CTS Termination of 120 Ohm. |

| | | |
|-------|---------|---|
| 20-21 | disable | This jumper should always be populated for RS-422 mode. |
|-------|---------|---|

Note: Sometimes, when operating in RS-422 or RS-485, it is necessary to configure termination and biasing of the data transmission lines. Generally this must be done in the cabling, since this depends on the installation of connections. Before applying the option, check your cable specification for proper impedance matching.



Figure 3

7 x 3 header block to enable Termination and BIAS resistors

2.2 Windows 7 / Vista / 2003 / XP / 2000 Driver Installation

You need to have administrator privileges to install any new drivers under Windows 7/ Vista / 2003 / XP / 2000. To install the driver or update the configuration please log onto Windows as "Administrator" or ask your system administrator to install the USB-COM driver.

You need to install driver first, prior to hardware installation. Do not connect the USB-to-Serial Adapter to the USB port of your computer, before you finish driver installation.

Please proceed with the following steps to install the driver:

1. Insert the "USB COM Series Driver and Utility" CD into your CD-ROM.
2. The "USB COM Series Driver and Utility CD" dialog box appears.
3. Under "Driver Installation", double click "Windows 7, Vista, 2003, XP, 2000 driver" to install the device driver.
4. The USB COM install program will auto-detect the OS type and install the driver automatically. (Note: in Windows 7 or Vista OS you will find another dialog box, please click on "OK" to confirm the drivers install program).

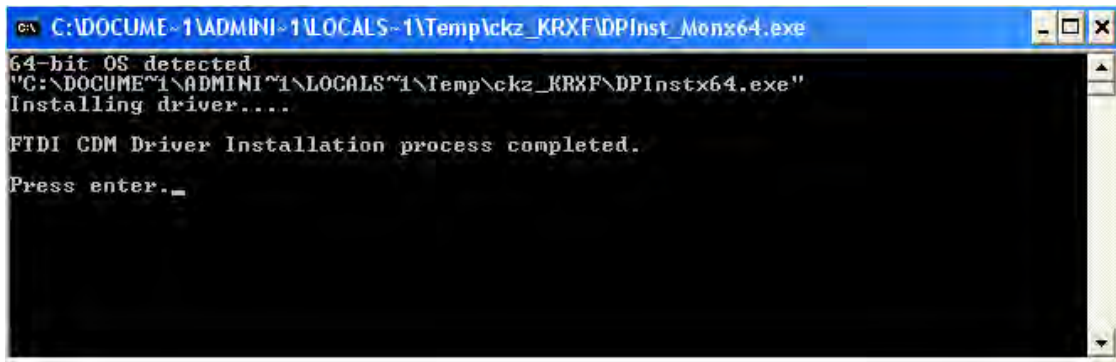

Figure 4

5. After the message “FTDI CDM Driver installation process completed” appears, press “Enter” to complete the driver installation.
6. Plug in the USB to Serial Adapter to the USB port of your computer. Windows will finish installing the driver files.

2.3 Check Installation

You can now verify the installation has been completed successfully by looking under Device Manager of the System Properties screen. (Go there by Start-Setting- Control Panel-System Properties-Hardware-Device Manager.

The device should have installed as a "USB Serial Port (COMx)" attached to "USB Serial Converter A/B".

2.4 Change COM Port Properties and COM Port Number

This feature is particularly useful for programs, such as HyperTerminal, which only work with COM1 through COM4. Please ensure that you do not change the COM Port Number already in use.

To change the virtual COM port properties:

- Select the "USB Serial Port"
- Click “Properties”.
- Select "Port Setting" and “Advanced”.
- Click the drop down arrow on COM Port Number and scroll to the required COM port. Select "OK".
- Return to the Device Manager Screen. You will see that the USB Serial Port installation has been changed to the new COM Port Number.

2.5 Uninstalling Windows 2003 / XP / 2000 Drivers

Please proceed with the following steps to uninstall the 2003/XP/2000 driver:

1. Insert the “USB COM Series Driver and Utility” CD into your CD-ROM.
2. The “USB COM Series Driver and Utility CD” dialog box appears.
3. Under “Driver Uninstalling”, double click “Windows 2003, XP, 2000 driver uninstall” to uninstall the device driver.
4. When following dialog box appears, double click “Clean System” to uninstall the 2003/XP/2000 drivers.



Figure 5

5. You need to disconnect all USB-COM-I from your PC, when the message below appears. Double click “OK” to start uninstalling Windows 2003/XP/2000 USB to Serial drivers.



Figure 6

6. Double click “Yes” to confirm it.

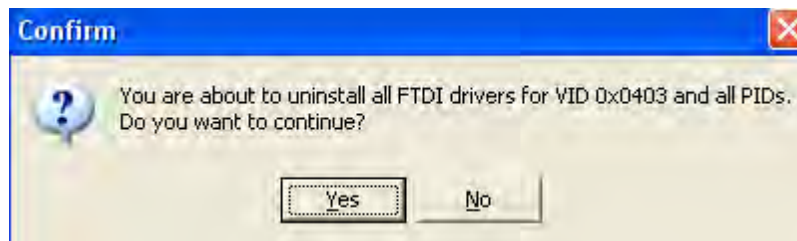

Figure 7

7. Click “No” to proceed.

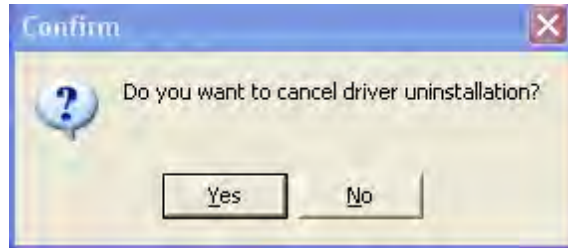

Figure 8

8. When the message “Status: System clean completed” appears, double click “Exit” to complete the USB to serial drivers uninstall.



Figure 9

9. Press “Start” button and select “Control Panel”.
10. Open the Add or Remove program.

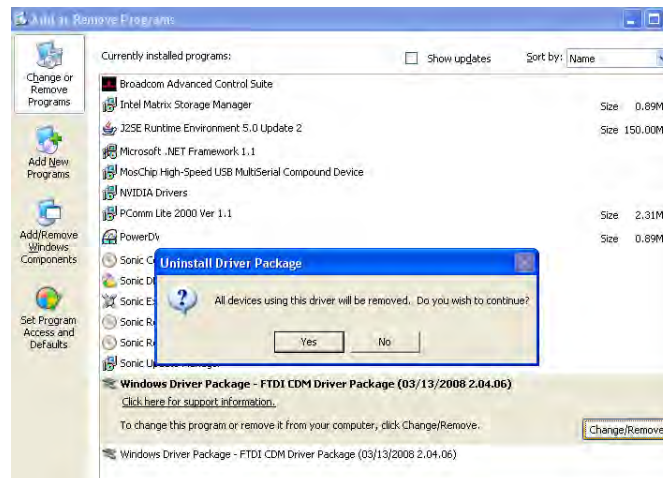

Figure 10

11. Remove the first “Windows Driver Package – FTDI CDM Driver Package (...)”.
12. Click “Change/Remove” and “Yes” to remove the first Windows Driver Package.
13. Remove the second “Windows Driver Package – FTDI CDM Driver Package (...)”.
14. Click “Change/Remove” and “Yes” to remove the second Windows Driver Package.
15. Reboot the computer to complete the driver uninstall.

2.6 Uninstalling Windows 7 or Vista Drivers

Windows 7 and Vista have many new security features. You need to proceed with the following steps to uninstall the Vista driver:

1. The USB to serial devices must connect to the PC.
2. Press “Start” button and select “Control Panel”.
3. Select “Classic View” from the top left hand corner and then “System” from the list.
4. Select “Device Manager” from the top left hand corner.

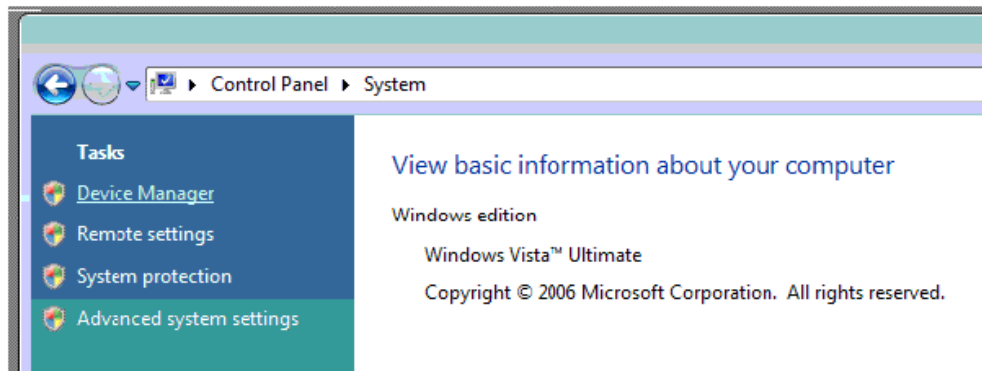

Figure 11

5. Locate your device under the ports (COM & LPT) section and right click on it to bring up the menu shown.

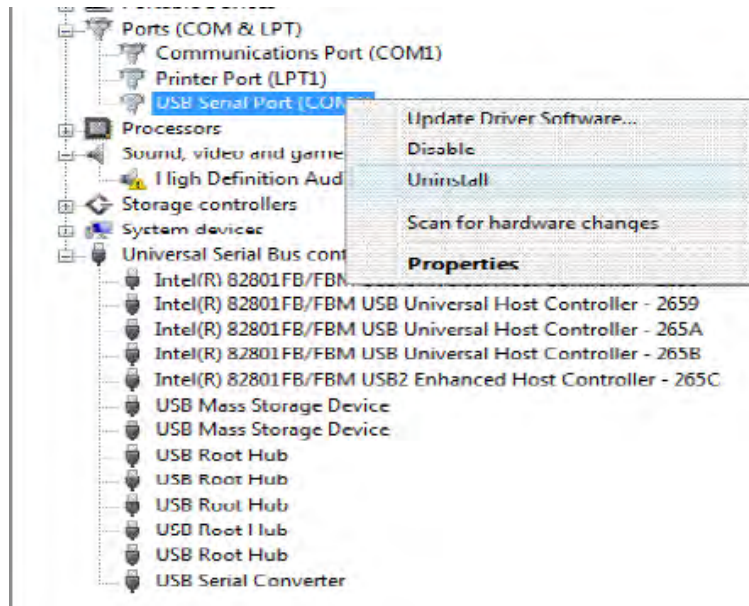

Figure 12

6. Select uninstall and be sure to click the box for “Delete the driver software for this device” in the next window and press “OK”.

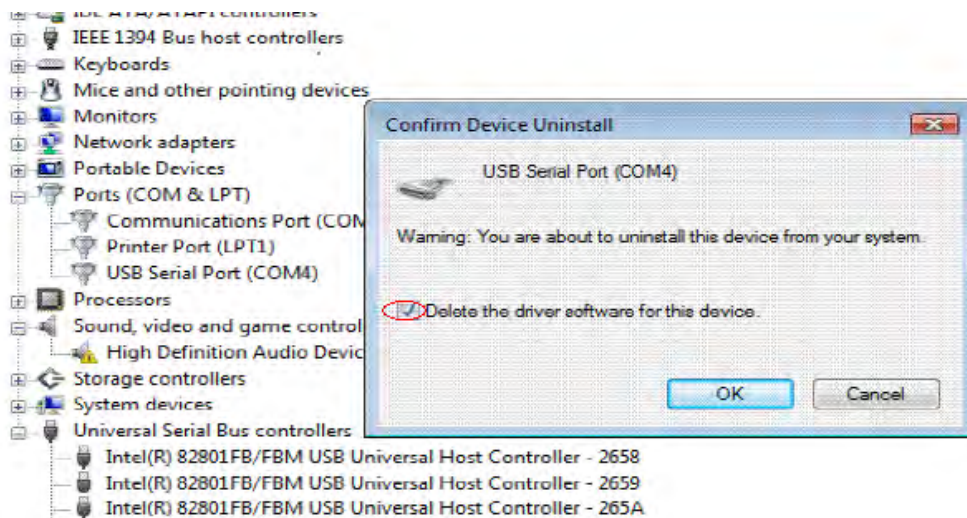

Figure 13

Note: if you have more than one USB-COM-1 installed in your PC, you need to repeat from step 5 to step 6 to delete the driver software for each port.

7. Locate your Device under the Universal Serial Bus Controllers section, and right click on it to bring up the menu shown.

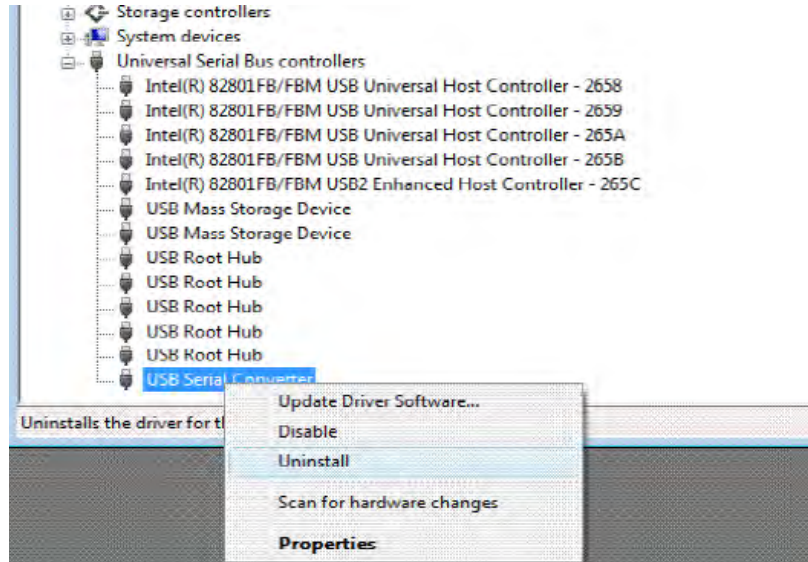

Figure 14

8. Select uninstall and be sure to click the box for “Delete the driver software for this device” in the next window and press “OK”.

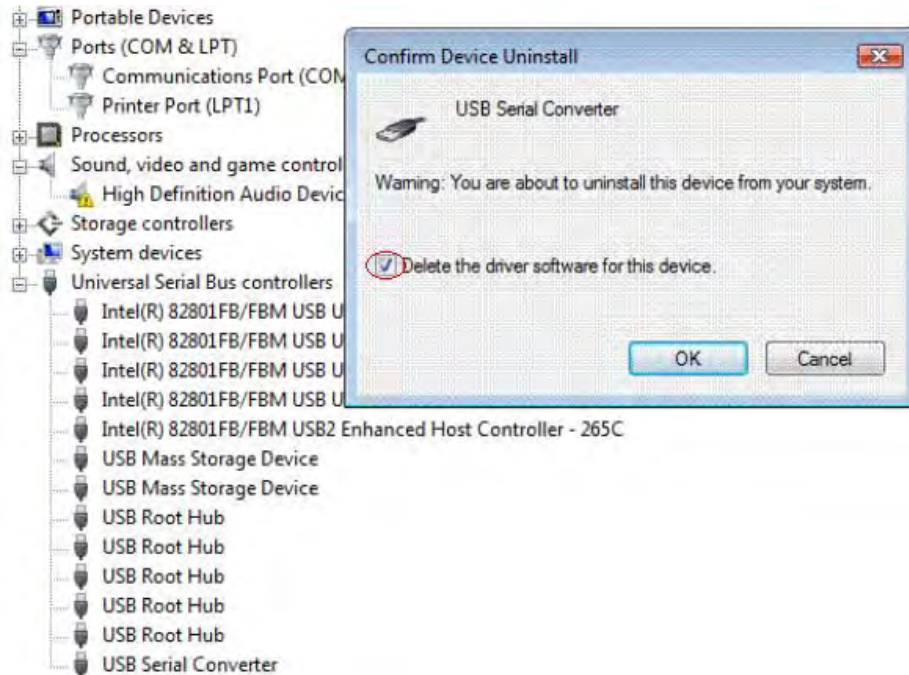

Figure 15

Note: if you have more than one USB-COM-i Converter installed in your PC, you need to repeat step 7 and step 8 to delete the driver software for all devices.

3. DB-9 Male Connector Pin & Signal Assignment

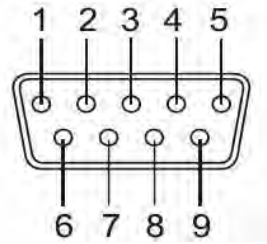

Figure 16

3.1 RS-422 Signal Pin-outs of DB-9 Male

| | |
|-------|-----------|
| Pin 1 | TxD- (A) |
| Pin 2 | TxD+ (B) |
| Pin 3 | RxD+ (B) |
| Pin 4 | RxD - (A) |
| Pin 5 | GND |
| Pin 6 | RTS- (A) |
| Pin 7 | RTS- (B) |
| Pin 8 | CTS+ (B) |
| Pin 9 | CTS- (A) |

RS-422 Signal Wiring

- Point-to-Point 4 Wire Full Duplex

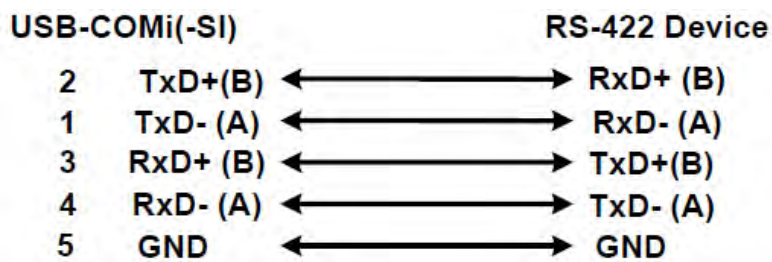

Figure 17

- RS-422 with Handshaking

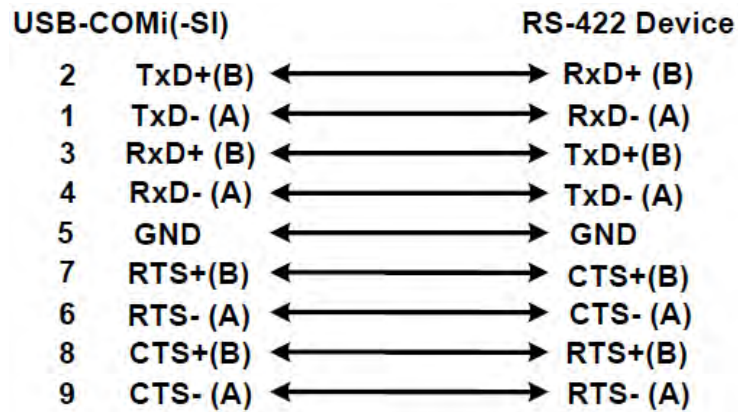

Figure 18

3.2 RS-485 4-Wire (Full Duplex) Signal Pin-outs of DB-9 Male

| | |
|-------|---------|
| Pin 1 | Tx- (A) |
| Pin 2 | Tx+ (B) |
| Pin 3 | Rx+ (B) |
| Pin 4 | Rx- (A) |
| Pin 5 | GND |

3.3 RS-485 2-Wire (Half Duplex) Signal Pin-outs of DB-9 Male

| | |
|-------|-----------|
| Pin 1 | Data- (A) |
| Pin 2 | Data+ (B) |
| Pin 5 | GND |

RS-485 Signal Wiring

- Point-to-Point 4-Wire Full Duplex

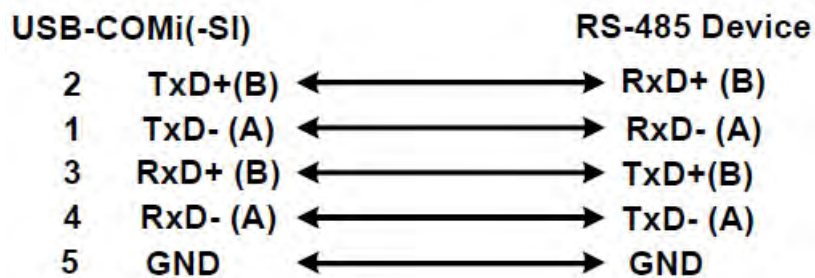

Figure 19

- Multi-drop RS-485 2-Wire Half-duplex

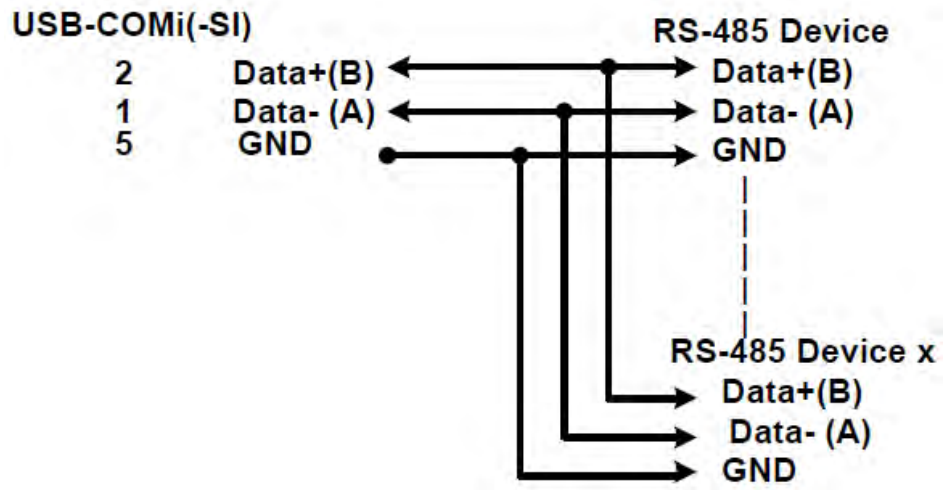

Figure 20

4. Notes, Tips, and Warnings

Note

Note: Sometimes, when operating in RS-422 or RS-485, it is necessary to configure termination and biasing of the data transmission lines. Generally this must be done in the cabling, since this depends on the installation of connections. Before applying the option, check your cable specification for proper impedance matching. Reference section 2.1

Note: if you have more than one USB-COM-1 installed in your PC, you need to repeat from step 5 to step 6 to delete the driver software for each port. Reference section 2.6 step 6.

Note: if you have more than one USB-COM-i Converter installed in your PC, you need to repeat step 7 and step 8 to delete the driver software for all devices. Reference section 2.6 step 8

Tip

N/A

Warning

N/A

Safety

- Read the entire Product Manual before implementing this product for your application. This manual contains important information about electrical connections that must be followed for safe and proper operation.
- Inspect the product closely for visual defects before putting it to use.
- Keep away from areas where moisture builds, this product contains electrical components that can be damaged by moisture build up, this can adversely affect your equipment connected to it.
- Do not disassemble the product. Handling the product's internal components can expose it to ESD (Electro-Static Discharge) hazards that can affect the function of the device.
- If this product is not functioning properly, email our support team at support@coolgear.com.

5. Supporting References

| Document | Link |
|----------------------|---|
| Website Product Page | https://www.coolgear.com/product/single-port-usb-to-rs422-485-adapter |

© 2017 Coolgear, Inc. All Rights Reserved. All products and accompanying digital documentation including images are the property and / or trademarks of Coolgear Inc. Coolgear Inc. are continuously improving upon its products. Product specifications are subject to change without notice.