

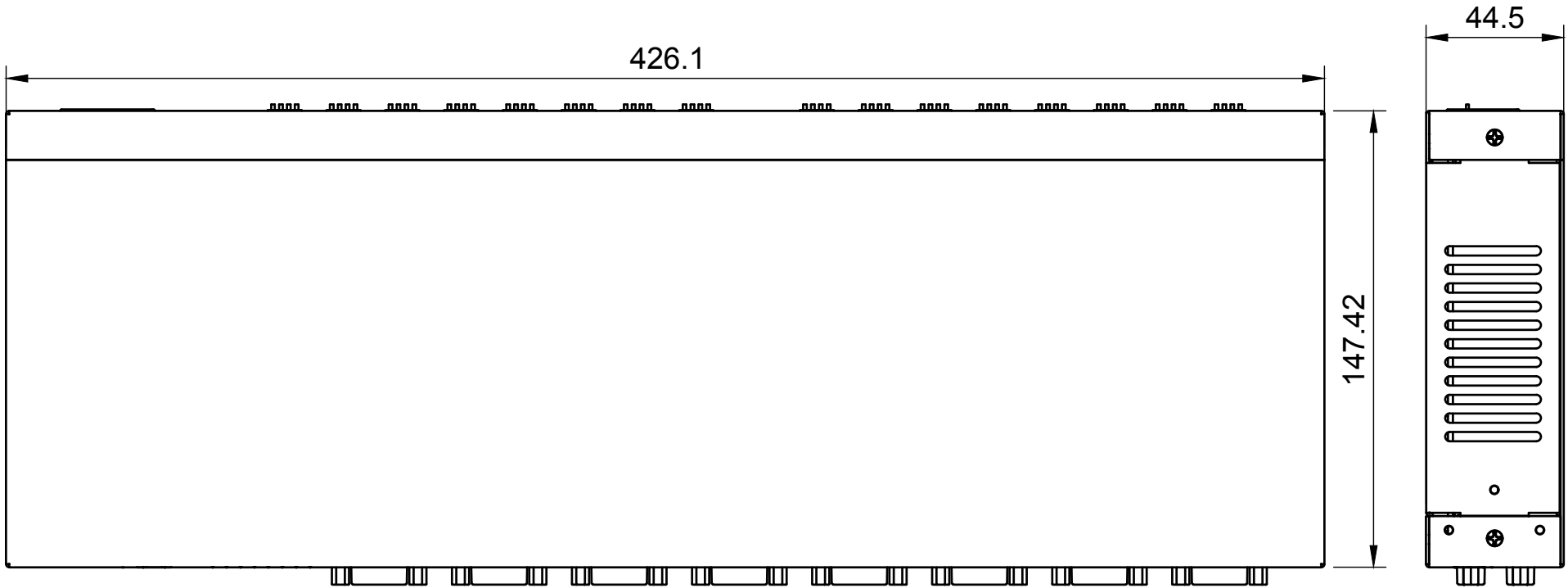

# Basic Measurements

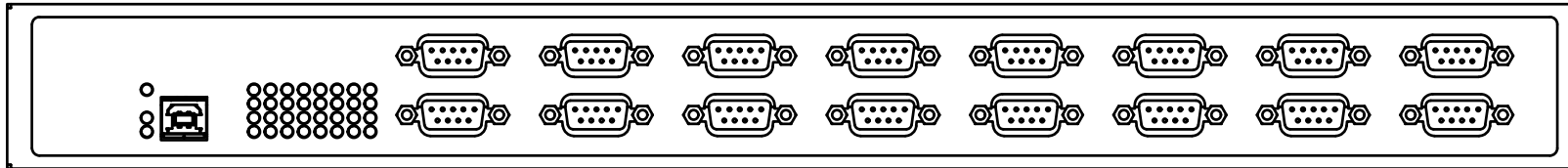

	Model #: <b>USB-16COMi-RM</b>	
	Drawn by: Leo Pinto	Scale: 1:2
Drawn Date: 10/5/21	Tolerance: +/- 0.15mm	
Notes:	Contact: support@coolgear.com	
	Web: coolgear.com	
	A4	1/4



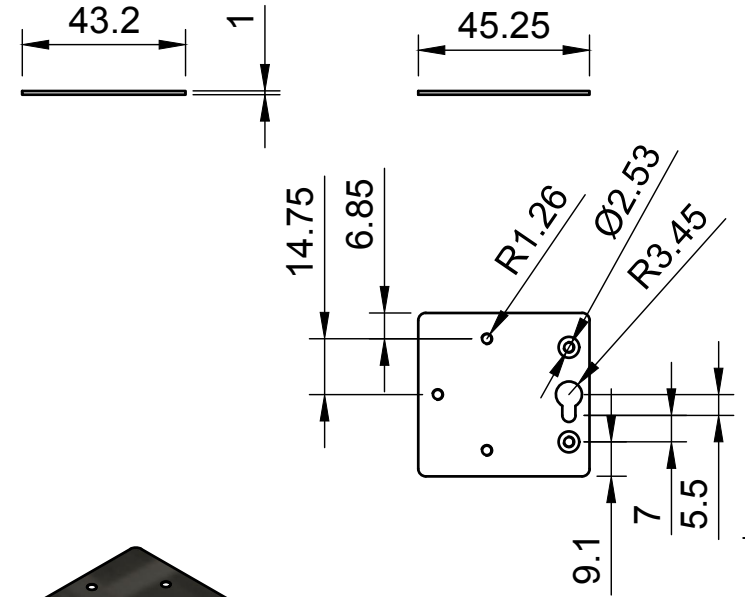
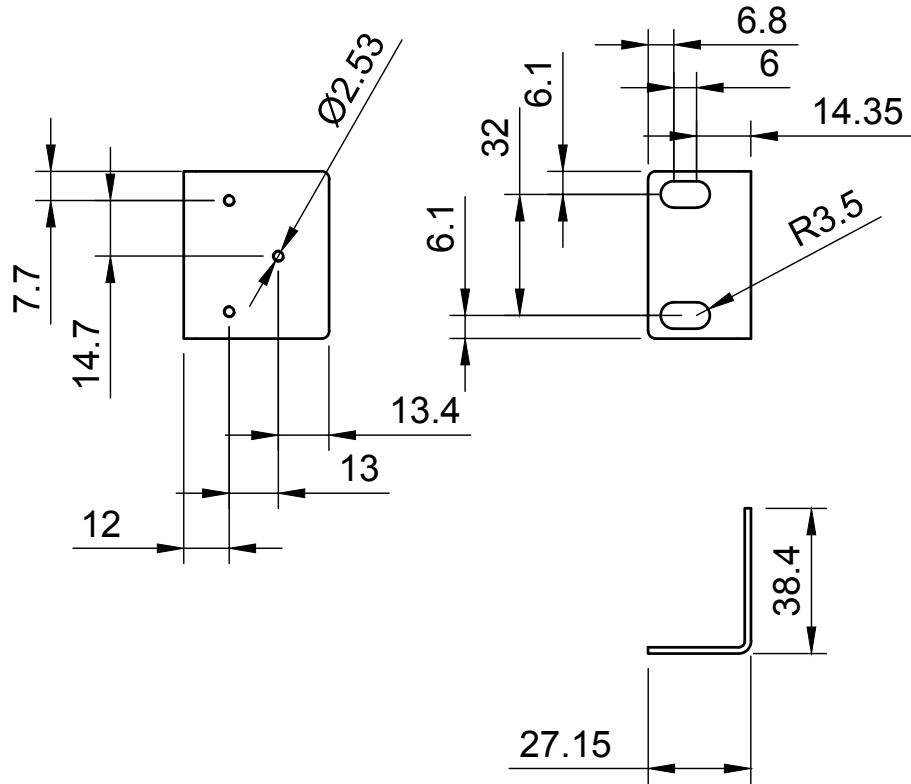

# Accessories

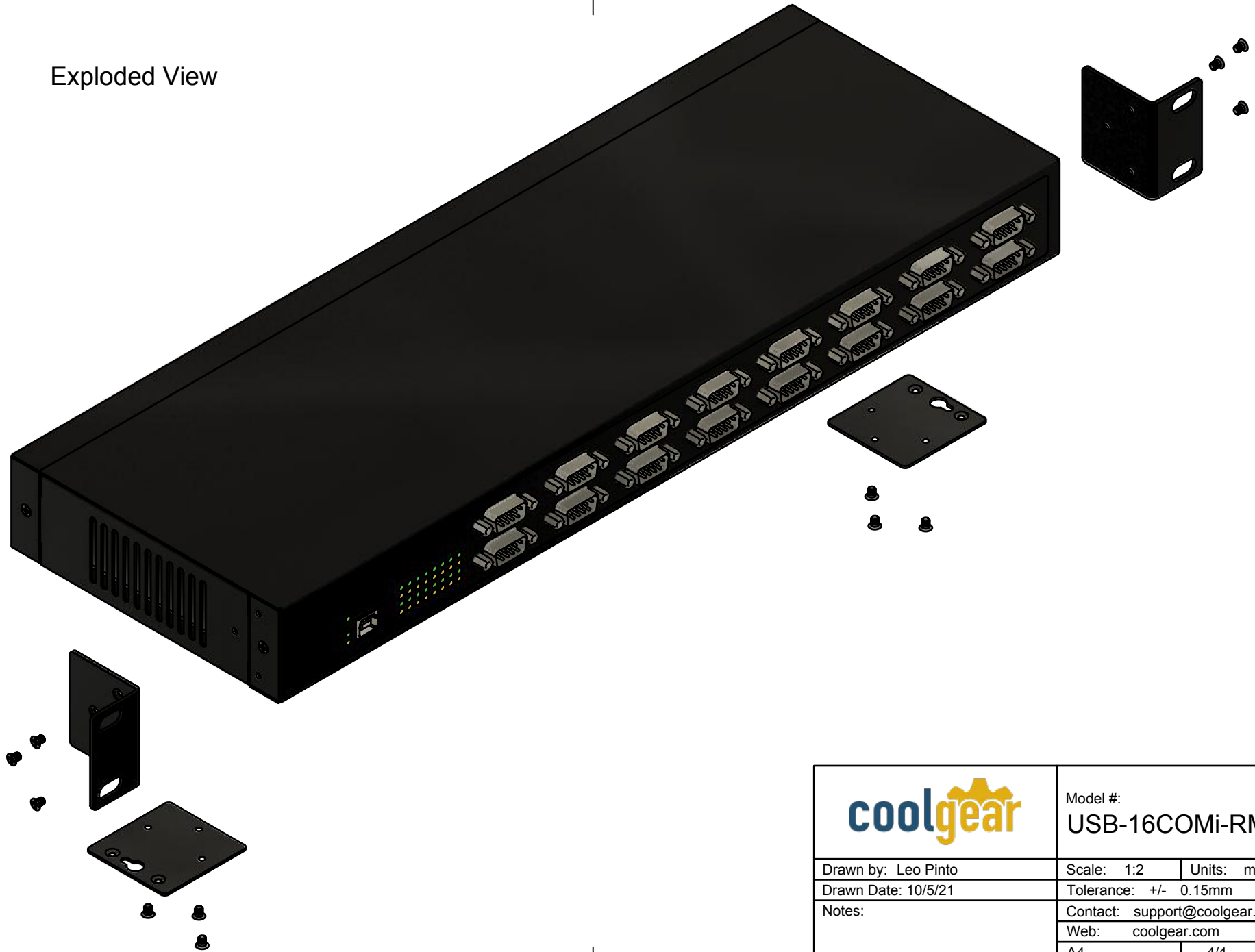

		Model #:	
		USB-16COMi-RM	
Drawn by: Leo Pinto	Scale: 1:2	Units: mm	
Drawn Date: 10/5/21	Tolerance: +/- 0.15mm		
Notes:	Contact: support@coolgear.com		
	Web: coolgear.com		
	A4	3/4	

Exploded View



		Model #: USB-16COMi-RM	
Drawn by: Leo Pinto		Scale: 1:2	Units: mm
Drawn Date: 10/5/21		Tolerance: +/- 0.15mm	
Notes:		Contact: support@coolgear.com	
		Web: coolgear.com	
		A4	4/4